

LUMIÈRE CONFIGURATION - B (NO LIGHTS)

LUMIÈRE LIGHT WALL

PRODUCT CODE: LLW10BNL



On frame On graphic

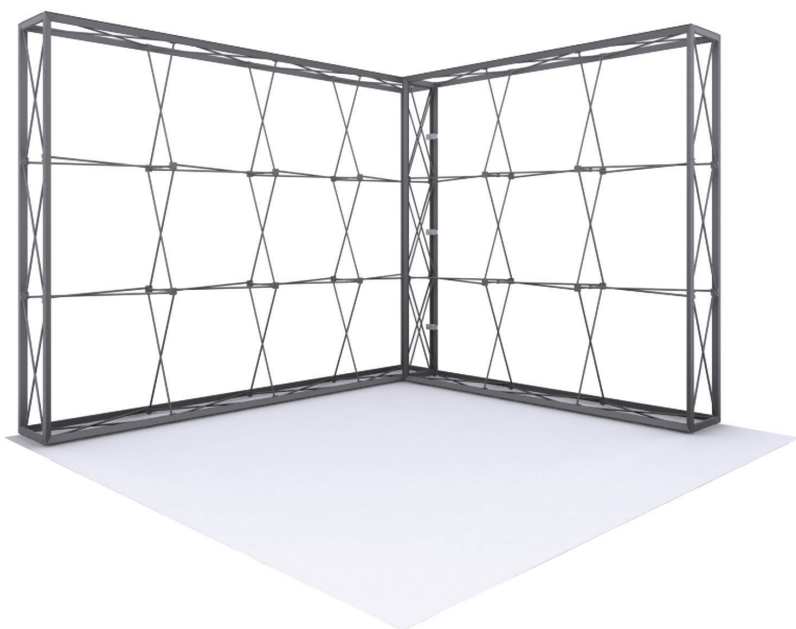

L Link Connector

PRODUCT DESCRIPTION

Introducing the Lumiere Light Wall! A combination of innovative silicone-edge graphics and RPL fabric pop ups offers an easier and more cost effective SEG option. This SEG style display has the depth of the RPL so you can expose more of your message using endcap graphics. The Lumiere shrinks down in size - simply collapse the geometric frame and the SEG bungeed channel bars, and fold or roll the fabric graphics. Setup can be done by 1 person and in 5-10 minutes. SEG portability is easy and stylish.

DISPLAY DIMENSION	118.1" W x 88.6" H x 103" D
--------------------------	-----------------------------

GRAPHIC DIMENSIONS

4X3 MAIN GRAPHICS	118.5" W x 89" H (2 Graphics)
4X3 END CAP GRAPHICS	14.25" W x 89" H (2 Graphic)
3X3 MAIN GRAPHICS	89" W x 89" H (2 Graphics)
3X3 END CAP GRAPHICS	14.25" W x 89" H (1 Graphic)

FRAME CONFIGURATION QUANTITY

4X3 FRAME	1 Frame
3X3 FRAME	1 Frame

GRAPHIC MATERIAL

Stretch Fabric

GRAPHIC FINISHING

Silicone beading is sewn around the perimeter of the fabric graphic. Silicone beading is hidden from view once installed.

DISPLAY CONSTRUCTION

Aluminum Frame

SHIPPING WEIGHTS & DIMENSIONS

4x3 Lumiere Light Wall (1 box)	
Shipping Weight	35 lbs (frame only) 39 lbs (with graphics)
Shipping Dimensions	34" L x 14" W x 9" H
3x3 Lumiere Light Wall (1 box)	
Shipping Weight	28 lbs (frame only) 32 lbs (with graphics)
Shipping Dimensions	34" L x 14" W x 9" H

GRAPHIC TURN AROUND TIME

2 business days after proof approval

AVAILABILITY	CA and PA
---------------------	-----------

LUMIÈRE CONFIGURATION - B (NO LIGHTS)

LUMIÈRE LIGHT WALL
PRODUCT CODE: LLW10BNL

AVAILABLE ACCESSORIES



Lumiere Front Lit -
Black Light LED



Lumiere Front Lit -
Silver Light LED



Lumiere Black Light
(150 W)



Lumiere Silver Light
(150 W)



T135 LED Light



LED Light Bracket

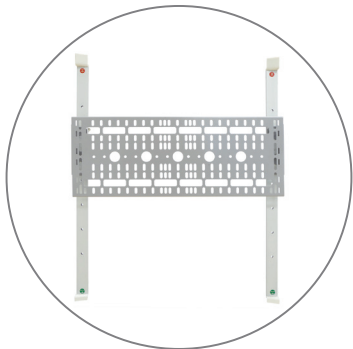

Monitor Bracket

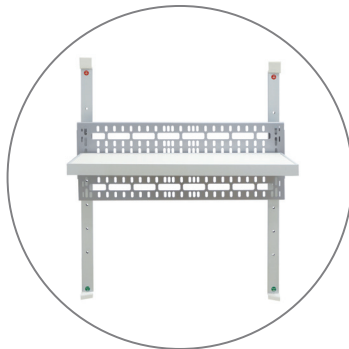

Shelf



Internal Showcase



La Caja Case



Genie Counter Case

LUMIÈRE CONFIGURATION - B (NO LIGHTS)

LUMIÈRE LIGHT WALL
PRODUCT CODE: LLW10BNL

PARTS LIST



Qty 1 - 4x3 Pop Up Frame



Qty 1 - 3x3 Pop Up Frame



Qty 4 - 4 Section Channel Bars



Qty 12 - 3 Section Channel Bars

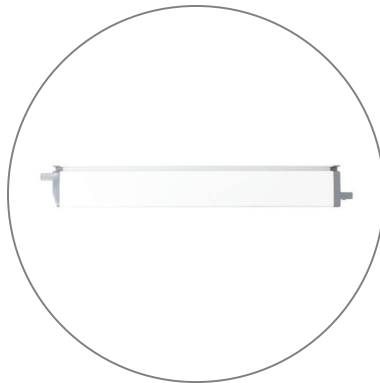

Qty 8 - Top & Bottom Endcaps



Qty 2 - Carry Bags



Qty 2 - Channel Bar Bags

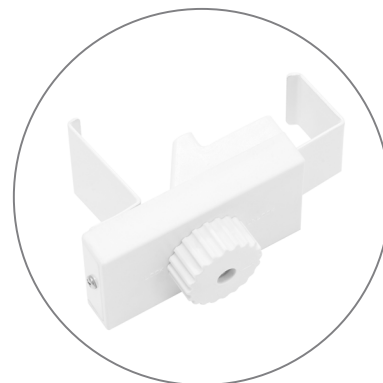

Qty 3 - L Link Connectors

LUMIÈRE CONFIGURATION - B (NO LIGHTS)

LUMIÈRE LIGHT WALL

PRODUCT CODE: LLW10BNL

SET UP INSTRUCTIONS

Set Up Pop Up Frame



a. Place frame with the adjustable feet facing down.

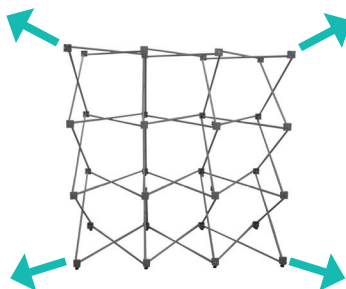

b. Expand the frame.

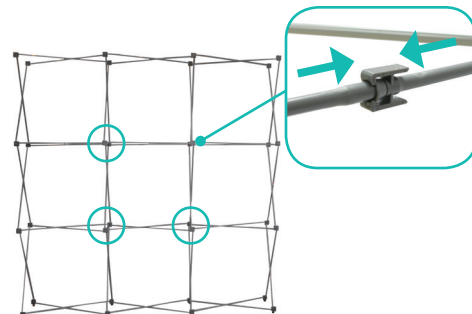

c. Close frame by pushing the outside of the frame until male and female ends connect.

Insert Channel Bars

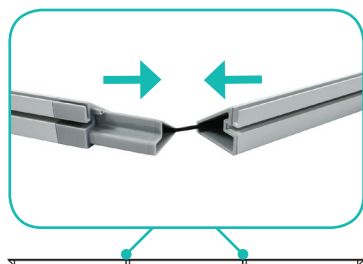

a. Expand each channel bar. Follow bungee to connect.

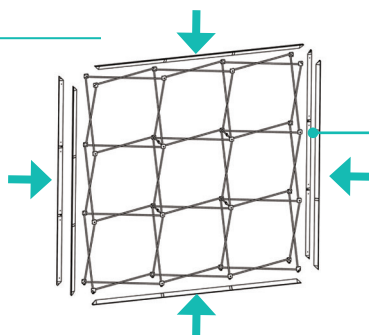

b. Attach channel bars to frame.

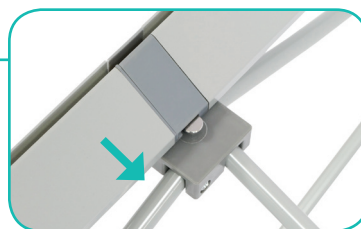

c. Slide channels bars onto frame, from top to bottom, then secure onto metal peg.



d. Attach the top and bottom end-caps on each side of the frame.

Install Graphic



a. In each corner, insert the silicone edge beading into the groove.



b. Then insert the remainder of the beading.



c. Repeat graphic installation on the end caps.

Optional Accessories

Light Bracket:

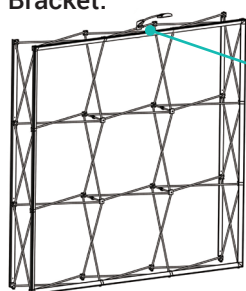

a. Snap the LED Light Bracket on top of the frame. Then slide the LED Light onto the bracket.



Stabilized Feet:

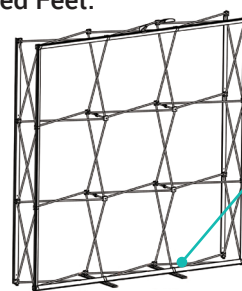

a. From the back, lift frame and insert adjustable feet onto stabilized feet. Then slide stabilized feet toward and insert onto the adjustable feet.



LUMIÈRE CONFIGURATION - B (NO LIGHTS)

LUMIÈRE LIGHT WALL
PRODUCT CODE: LLW10BNL

SET UP INSTRUCTIONS

Connecting Return Wall

Front View

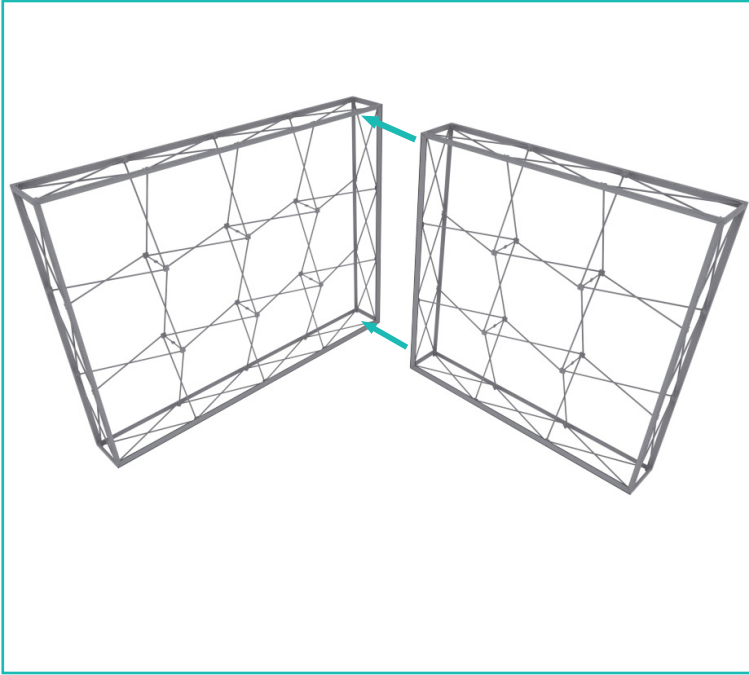

Back View

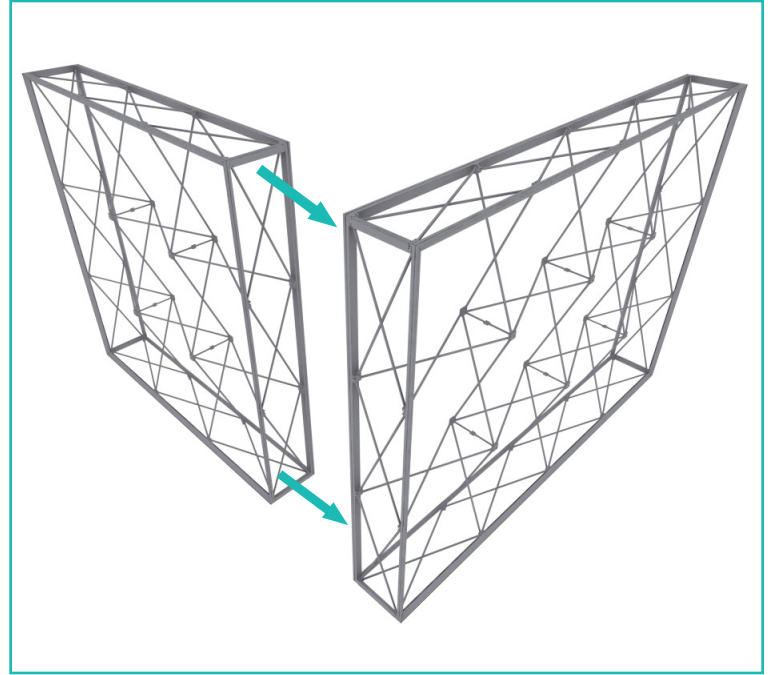

Adjoin the 3x3 frame perpendicular (90° angle) to the front side of the 4x3 frame.

Note: Rendering shown without graphics for clarity. 4x3 front side graphic must be installed before connecting frames.

L Link Connection



*Starting from behind, pull the 4x3 graphic away to make space for L Connector.



Slide L Connector onto the channel bars of both frames.

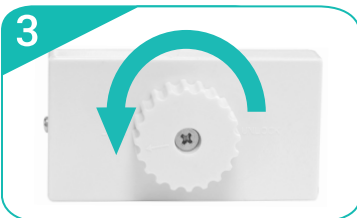

Turn dial to the left to lock the L Connector in place. Repeat for each vertical section (3 total).

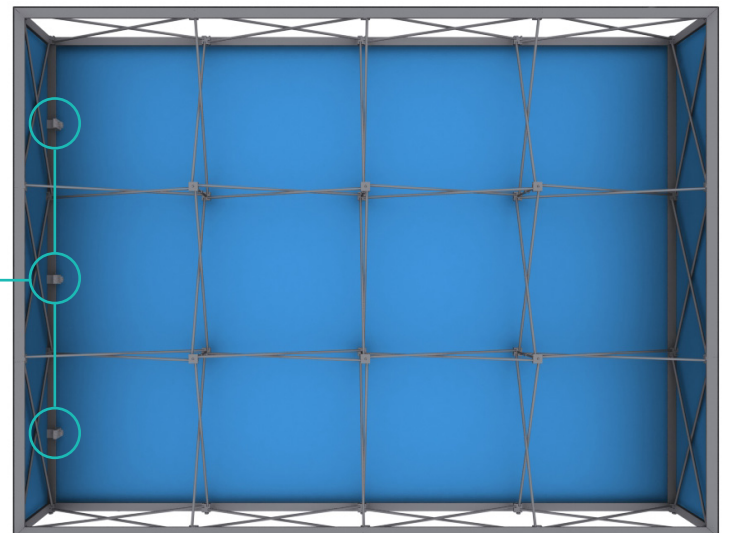

*Back side of 4x3 shown above.

LUMIÈRE CONFIGURATION - B (NO LIGHTS)

LUMIÈRE LIGHT WALL
PRODUCT CODE: LLW10BNL

TEMPLATE GUIDE

Front View

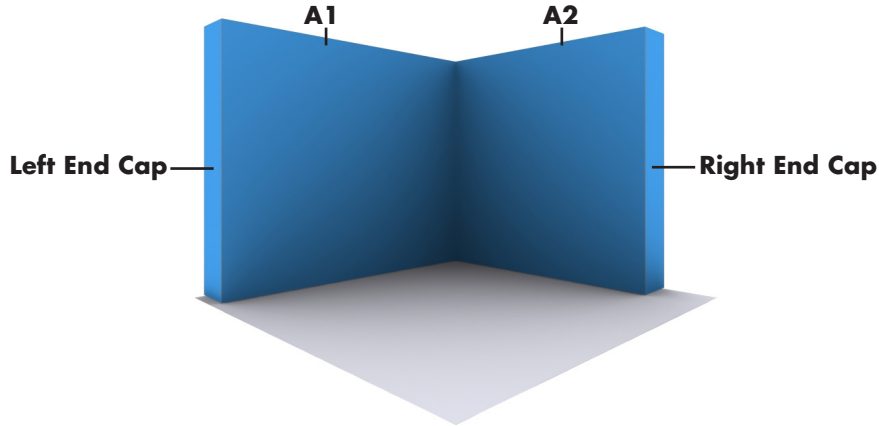

Back View

